

Encore[®]

Encore Hybrid Electric Heat Pump Water Heater with LeakGuard™ is the most efficient water heater available

EFFICIENCY

- Up to 4.07 UEF reduces operating cost
- ENERGY STAR® certified
- Title 24 Compliant (JA13 Ready)

PERFORMANCE

- Delivers hot water faster than most standard electric water heaters
- Ambient operating range: 37-145° F is widest in class, offering more heat pump operation annually; designed to meet Northern Climate Spec (Tier 4)
- Quiet Operation

EASY INSTALLATION

- Universal top and side water connections
- Quick access to electrical junction box
- Duct ready design
- Easily replaces a standard electric water heater

INTEGRATION

- LED Screen with built-in water sensor alert with audible alarm
- Built-in Wi-Fi powered by EcoNet^{®2} (2.4 GHz only) and free mobile app gives users control over water systems, allowing for customizable temperature, vacation settings, energy savings and system monitoring at home or away
- Demand Response Ready with built-in EcoPort™ (CTA-2045 Port)
- **LeakGuard™ leak detection and prevention system** with factory installed 360° leak detection cable and auto shutoff valve (included in box) auto water shut off valve limits leaks to no more than 20 ounces of water^{1,3}

OPERATION MODES

- Energy Saver – default setting
- Heat Pump Only
- High Demand
- Electric Heat Only
- Vacation/Away: 2-28 days (or placed on hold indefinitely)

PLUS...

- Premium grade anode rod extends the life of the tank
- Dip tube diffuser reduces sediment improving efficiency and tank life
- 3/4" NPT water inlet and outlet; 3/4" condensate drain connections
- Incoloy stainless steel resistor elements
- Dry-fire protection
- Easy access, top mounted washable air filter
- 2" Non-CFC foam insulation
- Enhanced flow brass drain valve
- Temperature and pressure relief valve installed
- Design certified to NSF/ANSI 372 (Lead Content)

WARRANTY

- 10-Year limited tank and parts warranty, 2-year limited labor warranty

See Residential Warranty Certificate for complete information

Units meet or exceed ANSI requirements and have been tested according to D.O.E. procedures. Units meet or exceed the energy efficiency requirements of NAECA, ASHRAE standard 90, ICC Code and all state energy efficiency performance criteria.



Encore Hybrid Electric Heat Pump

40, 50, 65 and 80-Gallon Capacities
208-240 Volt / 1 PH
30 Amp Electric



LEED Points = 3

See specifications chart on back.

¹Available with select models. ²Wi-Fi broadband internet connection required. ³Source: Rheem Leak-Sensing Data; testing under a vacuum lock using 50-gallon tank, no expansion tank, average tank pressure of 40 psi, assuming no additional faucets are opened.

Hybrid Electric Heat Pump Specifications

DESCRIPTION			ENERGY INFO		FEATURES						SHIPPING WEIGHTS	
NOMINAL GALLON CAPACITY	RATED GALLON CAPACITY	MODEL NUMBER	ELECTRIC BREAKER SIZE	UNIFORM ENERGY FACTOR (UEF)	COMPRESSOR BTU/H	UEF FIRST HR. RATING G.P.H.	RECOVERY IN G.P.H 90° F RISE	ELEMENT WATTAGE	TOTAL UNIT WATTAGE	MAX AMPS	UNIT WT. (LBS)	APPROX. SHIP WT. (LBS.)
Hybrid Electric HPWH with LeakGuard™ – 30AMPS												
40	36	10E40-HP5US30	30	3.83	4,200	60	26	4,500	5,000	21	166	184
50	45	10E50-HP5US30	30	3.88	4,200	67	27	4,500	5,000	21	185	203
65	59	10E65-HP5US30	30	4.05	4,200	76.6	27	4,500	5,000	21	245	289
80	72	10E80-HP5US30	30	4.07	4,200	87	27	4,500	5,000	21	261	306

Uniform Energy Factor and rated gallon capacity based on Department of Energy (DOE) requirements. All units have integrated Wi-Fi control board.

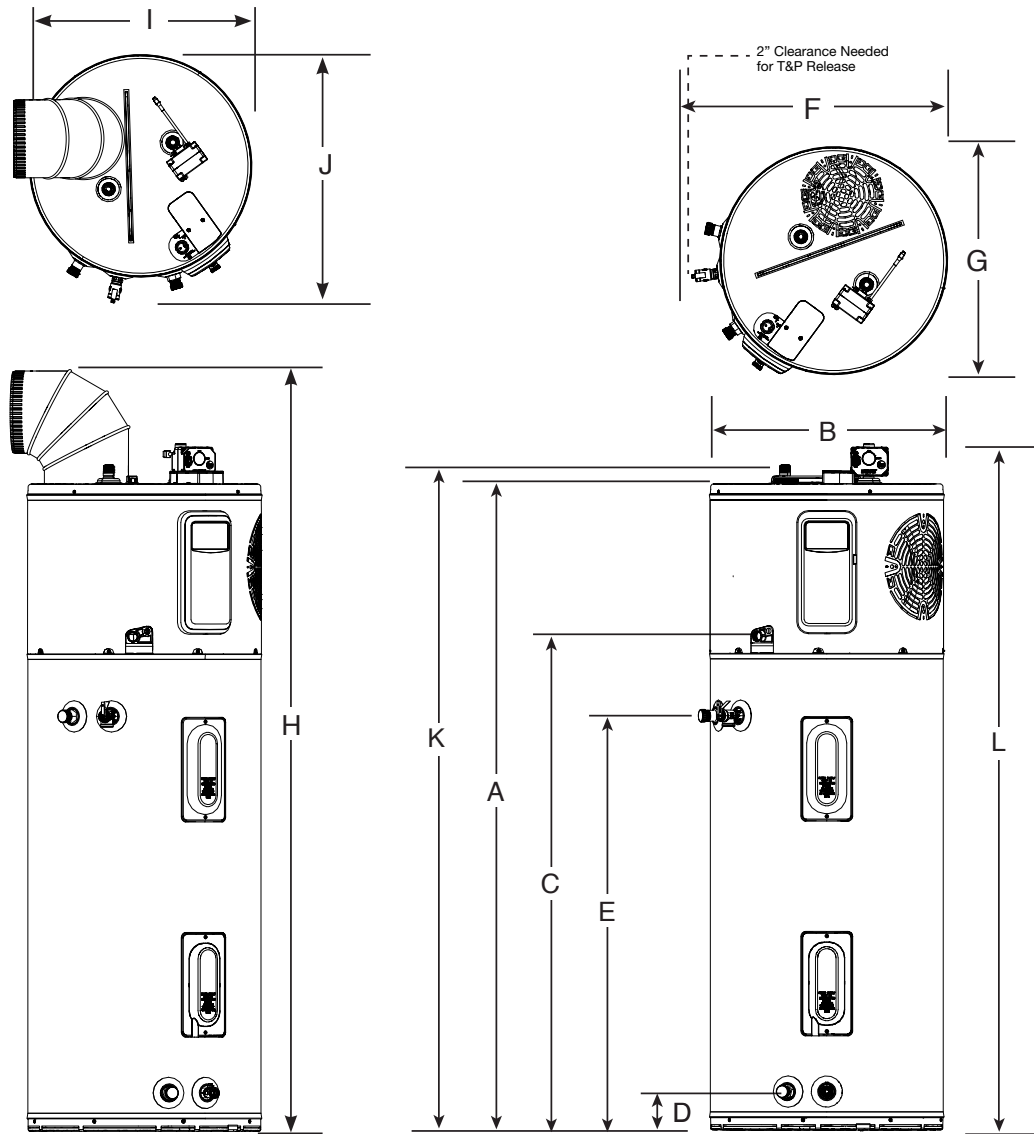

DESCRIPTION		DIMENSIONS (SHOWN IN INCHES)											
NOMINAL GALLON CAPACITY	MODEL NUMBER	A	B	C	D	E	F	G	H	I	J	K	L
40	10E40-HP5US30	62-5/16	20-1/4	47	3-5/8	39-5/8	23-3/8	20-1/2	78-7/8	22-3/8	23-1/4	64-15/16	67-7/16
50	10E50-HP5US30	61-3/4	22-1/4	47	3-5/8	39-5/8	25-3/8	22-1/2	78-5/8	24-3/8	25-9/16	64-3/8	66-7/8
65	10E65-HP5US30	64-3/16	24-1/4	49	3-7/8	42-3/8	27-1/2	24-5/8	81-1/8	26-1/2	27-3/8	66-13/16	69-5/16
80	10E80-HP5US30	74-3/16	24-1/4	59	3-7/8	42-3/8	27-1/2	24-5/8	91	26-1/2	27-3/8	76-13/16	79-5/16

Hybrid Electric Heat Pump Water Heater Installation Guidelines to Provide Optimal Efficiency

Heater: Not Ducted

Room size: Larger than 700 ft³ (e.g. 7' x 10' x 10').
Requirements: No additional ventilation needed.

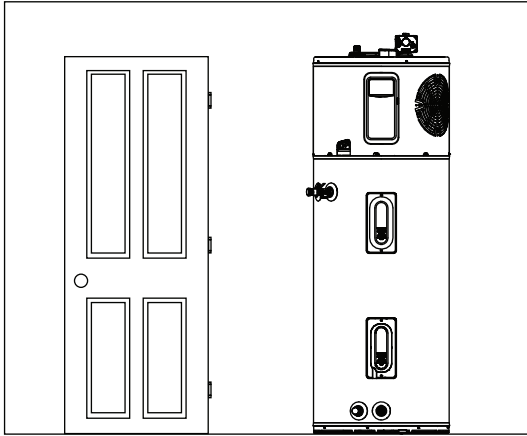

Heater: Not Ducted

Room size: Smaller than 700 ft³ (e.g. 7' x 10' x 10').
Requirements: Full louvered door OR two louvers top and bottom. See below.

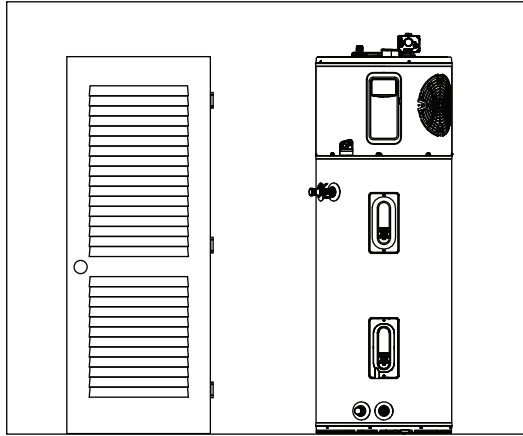

Heater: Not ducted

Room: Small Closet

Requirements: * Air gap under door equal to 18 in² (0.75" clearance).

* Louver must be located the same height on door as the air exhaust on heater.

* Heater air exhaust must be positioned towards louver within one foot of door.

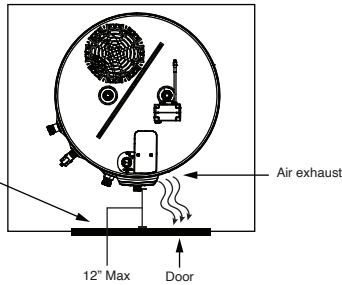
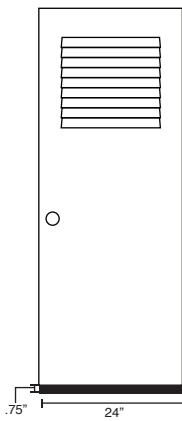

Heater: Ducted with inlet OR outlet duct

Room size: Any size room

Requirements: Air gap under door equal to 18 in² (0.75" clearance)

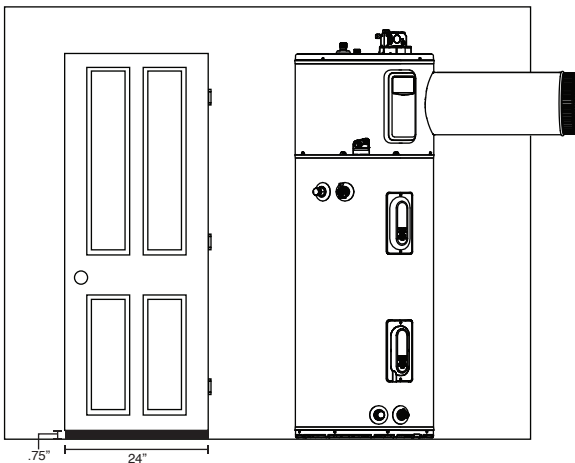

Heater: Ducted with inlet AND outlet duct

Room size: Any size room

Requirements: No additional ventilation needed.

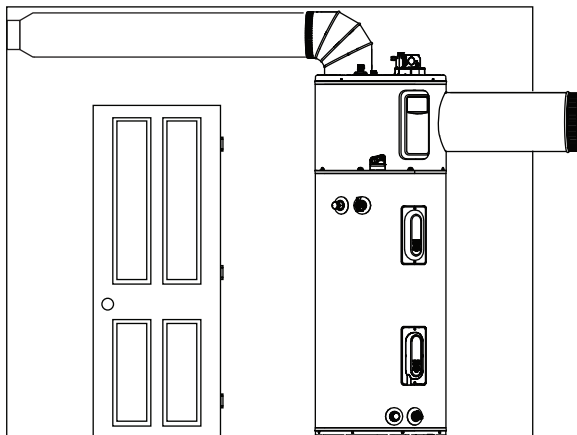

NOTE: Heat pump water heater will operate in rooms less than 700 ft³ down to 450 ft³ but at reduced energy efficiency and reduced performance output. Reduced energy efficiency and performance has not been evaluated by Rheem Manufacturing and not recommended for optimal performance of the unit. When unit is operated in a small enclosure, a door or wall with a minimum of 2.3 sq ft of louvers is recommended to provide proper air changes for unit function.

Encore®

Hybrid Electric Heat Pump Accessories List

PART NUMBER	DESCRIPTION	USE FOR
AP19134	Leak Sensor	Automatic detection of internal and external leaks
AS50618A	Shutoff Valve	Automatic shut off of water supply to unit
SP20882	Earthquake Isolation Kit	Installations in seismic regions
SP20883	Vibration Isolation Kit	Installation on non-concrete floors
SP20884	8" Diameter UL Certified Termination Kit	Termination to the outside or to the attic with 8" diameter
SP20885	7" Diameter UL Certified Termination Kit	Termination to the outside or to the attic with 7" diameter
SP20886	6" Diameter UL Certified Termination Kit	Termination to the outside or to the attic with 6" diameter
SP20887	5" Diameter UL Certified Termination Kit	Termination to the outside or to the attic with 5" diameter
SP20888	8" Collar for Flex Venting	Exhaust only to the outside ducting configuration (no inlet duct)
SP20889	25' Flexible 8" Diameter Duct Kit	For up to 25' of ducting
SP20890	8" Rigid Elbow Duct Kit	Installation in tight places where space needs to be minimized

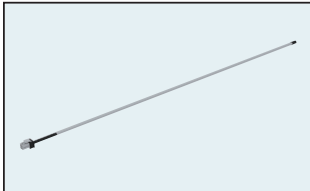

Leak Sensor



Shutoff Valve

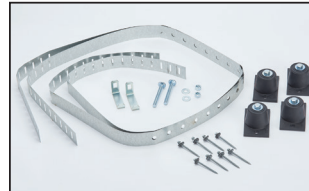

Earthquake Isolation Kit

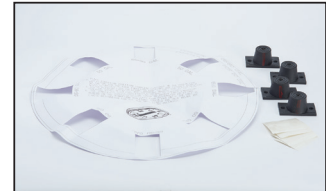

Vibration Isolation Kit

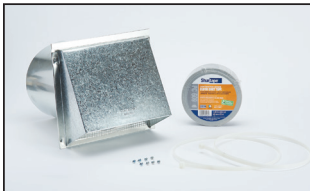

8" Diameter UL Certified Termination Kit



7" Diameter UL Certified Termination Kit



6" Diameter UL Certified Termination Kit



5" Diameter UL Certified Termination Kit



8" Collar for Flex Venting



25' Flexible 8" Diameter Duct Kit



8" Rigid Elbow Duct Kit